

FULL HEIGHT DOOR DETECTOR

CONTROL BOX FREE

Model: **SAR70EL-N**

SAR70EL-NS-24V (slim aluminum housing)
SAR70EL-NW-24V (wide aluminum housing)

SHORT FORM INSTRUCTION MANUAL

Tal Inc. or TAL ENGINEERING shall not be liable for any injury, loss, damage or other costs, Direct or consequential, arising out of the use of, or the inability of the purchaser to use the product. Before using or supplying to another for their use, the purchaser shall determine the suitability of the product for its intended use and the purchaser assumes all risks and liabilities in connection therewith.

Please refer to warnings and important information on last page.

This is a short form instruction manual, if you have **No** experience with similar systems please ask for the full detailed manual before installation.



General

This system is used to protect entrances of elevators equipped with automatic car doors. Protection is achieved via 70 Discrete Infrared Beams, which are transmitted between two edges. Therefore, protection area is limited to a thin sheet of 70 beams, which persists between the two edges. When one beam, or more, is obstructed, a relay is de-energized.















Faulty beam cancellation

This feature can be disabled or enabled by connecting or disconnecting blue cable wire of TX to +24V. Refer to fig No: 1 & 2.

If the controller senses an obstruction for a period of one minute, the microprocessor will designate the beam as faulty and cancel that beam. Where upon normal door operation will resume. The system will continue to operate normally until three successive beams are designated as faulty. If the Microprocessor senses that a faulty beam is restored it will after one minute null out the cancellation and the beam will be back in operation if this feature is disabled and the Microprocessor senses an obstruction the doors will remain open indefinitely. The bottom and top beams are not cancelled by the system when one of this beams become faulty the doors will remain open indefinitely.

Diagnostics

For diagnostics and trouble shooting there are two LEDs on RX edge and one LED on TX edge. These LEDs signalize to the user, by diagnostics codes, the status of the system as specified in the following chart:

	LED	Description
TX	Single LED 	When "ON" power to the system is applied and Microcomputer on TX edge is functioning properly.
RX		When left and right LEDs is "ON" then no beam is obstructed system is operating.
	 	When left LED is "OFF" and right LED is "ON" then one or more beams are obstructed.
	  X slow	When right LED is flashing slowly then there is one cancelled IR diodes on TX edge.
	  X fast	When right LED is flashing fast then there are more than one cancelled IR diodes on TX edge not possible to cancel more IR diodes. Early replacement of TX edge is required.
	  slow X	When left LED is flashing slowly then there is one cancelled receiving diodes on RX edge.
	  fast X	When left LED is flashing fast then there are more than one cancelled receiving diodes on RX edge not possible to cancel more receiving diodes. Early replacement of RX edge is required.
	 	When left and right LEDs are flashing alternately then the Synchronization signal between TX edge and RX edge is lost.

X = Don't care

 = Flashing LED
Power Supply

The SAR70EL-N should be powered from a 24VDCm (rectified unfiltered) source, capable to supply at least 100 mA.



Wiring: To operate the unit connect the wires according to the connection diagram. (Fig :2).

WIRE ASSIGNMENT

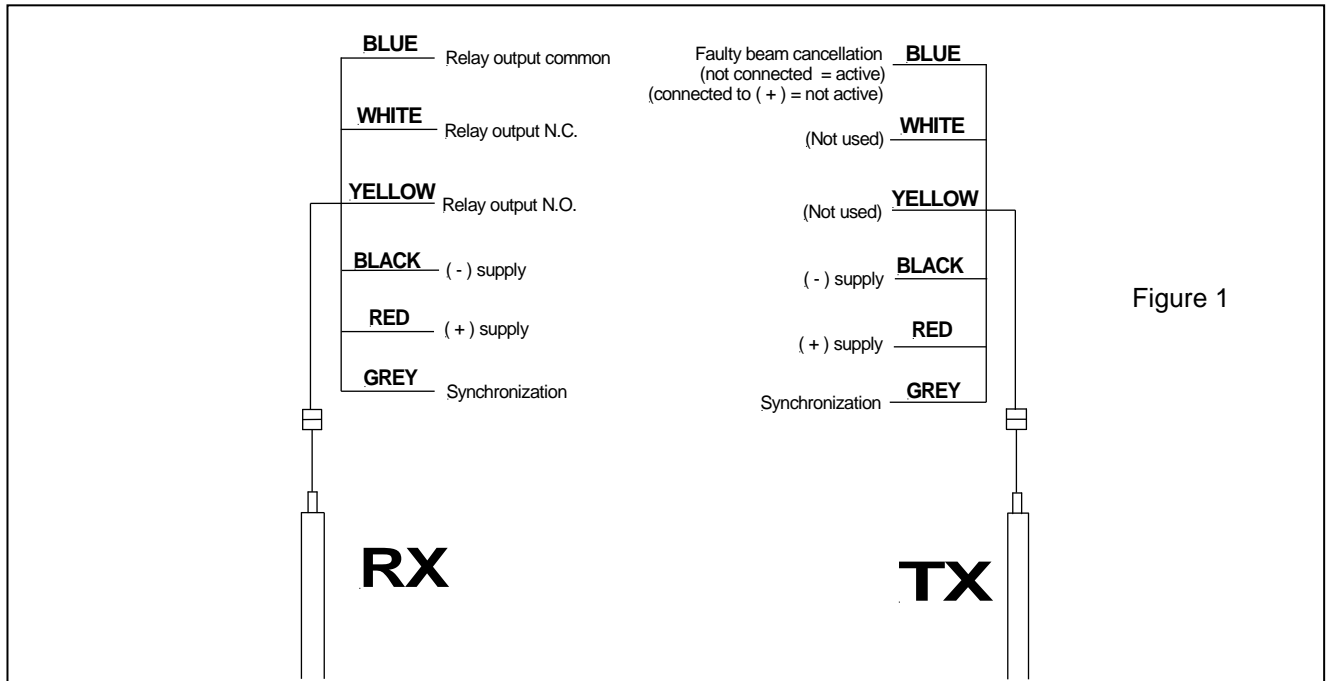

CONNECTION DIAGRAM

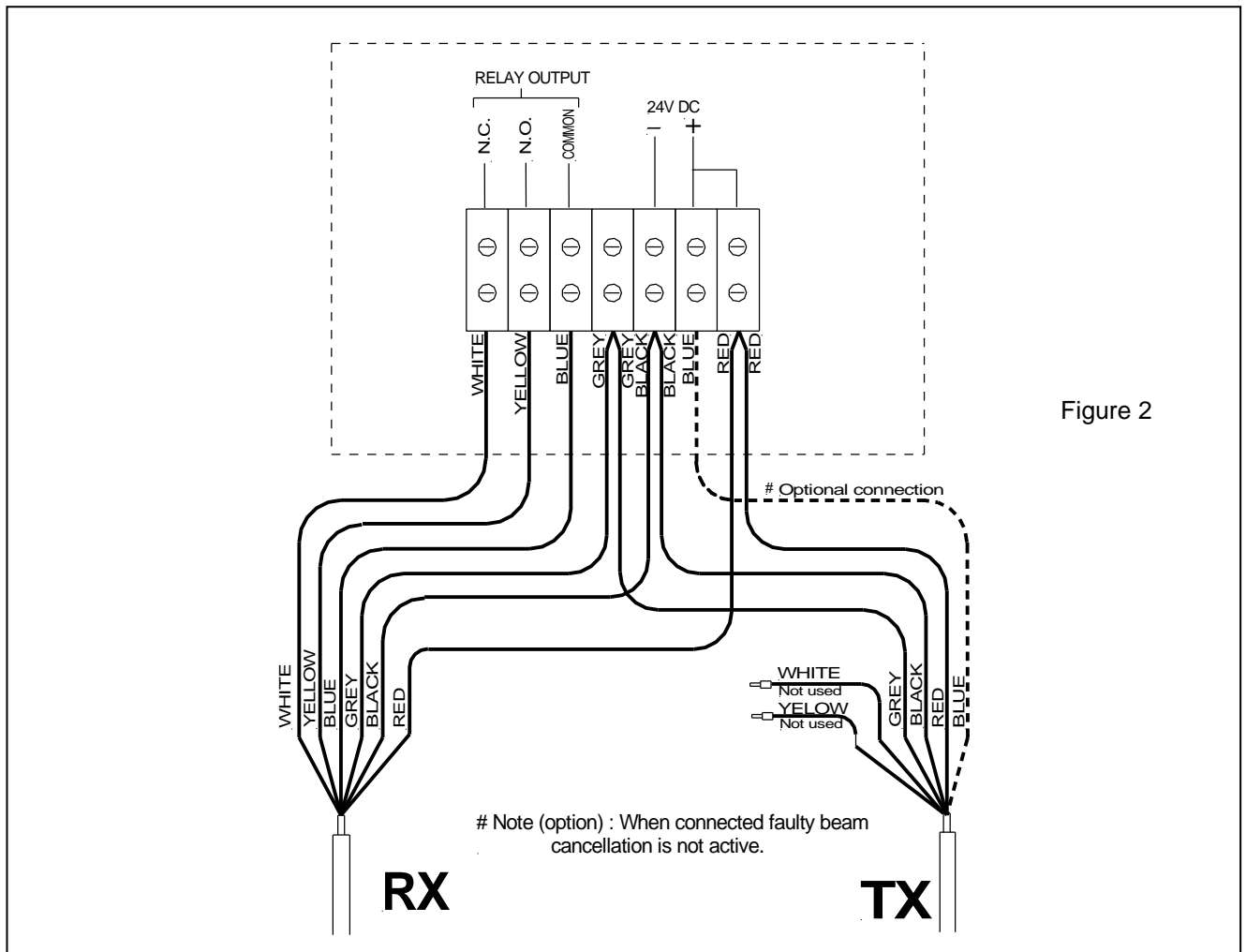

Output Details

RELAY OUTPUT

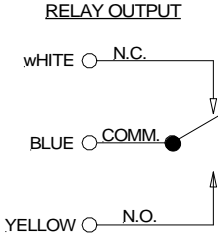

Both N.O. and N.C. contacts are available to user. Each contact can handle 1 Amp. @ 30V, resistive load.

ATTENTION! If the output relay is driving a non resistive load some protection mean should be taken to protect contact (varistor or diode or RC).

ATTENTION! If the output relay is driving a non resistive load some protection mean should be taken to protect contact (varistor or diode or RC).

RX

COMMENT: If the SAR70EL-N is installed in an elevator where a Photocell Unit is already exists, care should be taken to install the RX edge of SAR70EL-N on the same side of TX eye of the Photocell. This will eliminate possible interference between Photocell and SAR70EL-N.

WARNINGS AND IMPORTANT INFORMATION

1. It is the responsibility of the installer to ensure that on completion, the installation complies with all relevant codes and regulations.
2. Limitations of the SAR70EL-N:
 - A. The SAR70EL-N full height door detector will not detect the following objects:
 1. Transparent objects.
 2. Chains, ropes, ribbons, pipes, and similar objects with small cross-section.
 3. Small objects or thin objects.

The user of elevator shall hold his hand in the doorway in order to keep the doors from closing when passing doors with these objects or of similar nature.
Special precautions must be taken when passing through doors, protected by the SAR70EL-N full height door detector, with small children or dogs, which are connected by a ribbon or a chain since doors may close without detecting the ribbon or the chain. Small children or dogs must held on hands when passing trough the doors
 - B. The user shell not stay in the car door way for a period longer then 19 seconds, since in some SAR70EL-N models the protection is lost after 20 seconds, and door may close without protection.
 - C. The user of elevator shall not place in car doorway of elevator any objects in order to keep the doors open by the protection of the SAR70EL-N, for a long period.
 - D. The user shall check carefully that the object he expects to be detected by the SAR70EL-N is actually detected and the doors reopen when the object is presented in the doorway

The installer of the SAR70EL-N shall warn the users to these limitations.

3. Output relay contact: The user shall make sure that the current flowing through the output relay should not exceed 1Amp. load and the load connected to the contact shall be a resistive load only. If the current through the contact of the relay is more that 0.05 Amp. Then the Relay must be replaced every two years.
4. Packages: The packages and the enclosures of this product are not for other use else than for what they were designed to. The purchaser or user is instructed to destroy the packages immediately after their content is taken out.

WARNING

THE SAR70-EL-N LIGHT CURTAINS ARE NOT A SAFETY SYSTEM and must not be used as such. They are not designed for personnel safety applications, and must not be used as a stand-alone personnel safety system. SAR70-EL-N light curtains are for Elevator use only.

